



FOR MEDIUM-TO-LARGE
FIRESTOP PENETRATIONS

ArmaProtect MM20 Firestop mortar

Firestop mortar for mixed fire seals
in walls and floors

- // Cables, cable bundles and cable trays
- // Combustible pipes
- // Busbars
- // Climasplit

www.armacell.com

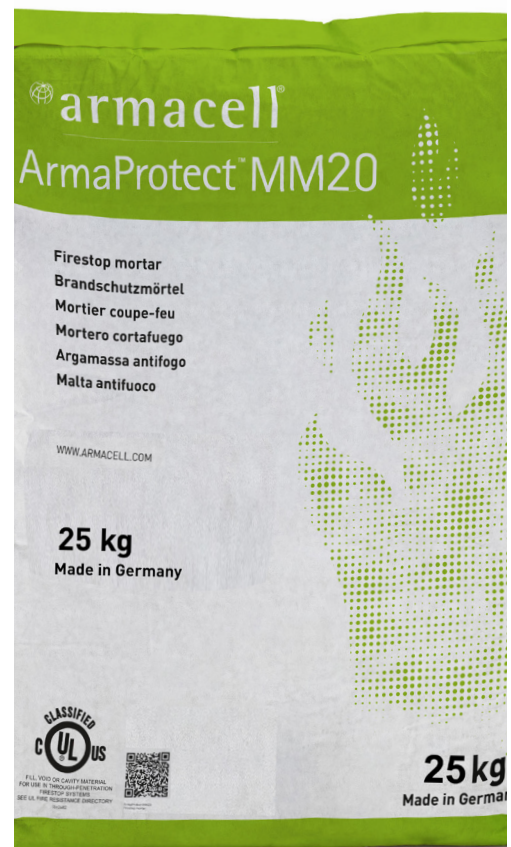

 **armacell**[®]
ArmaProtect[™]

INSTRUCTIONS FOR USE

Before you begin, ensure surfaces are solid and free of any adhesion-reducing substances such as dust. Absorbent surfaces should be pre-wet with water. The mortar consistency needs to be adapted so that all components are filled without cavities.

// Wall installation

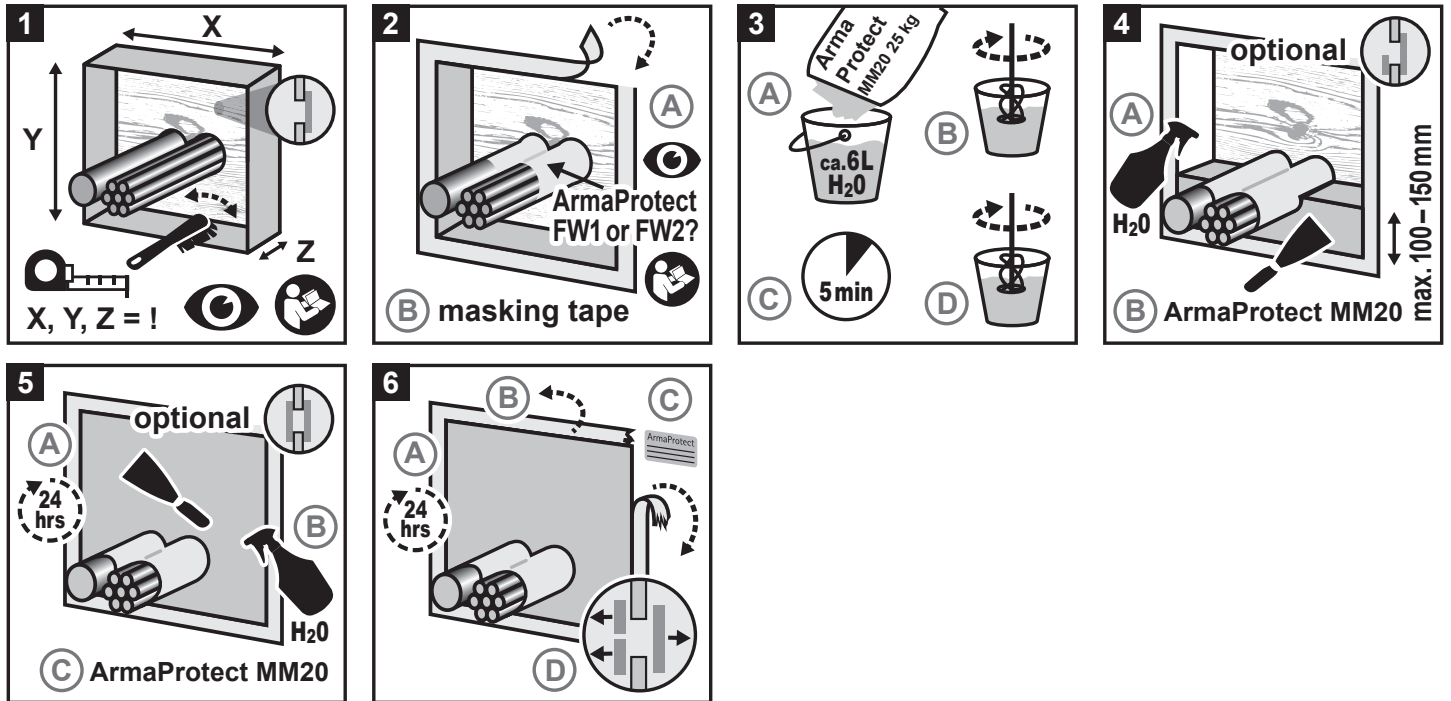

// Repairing cracks

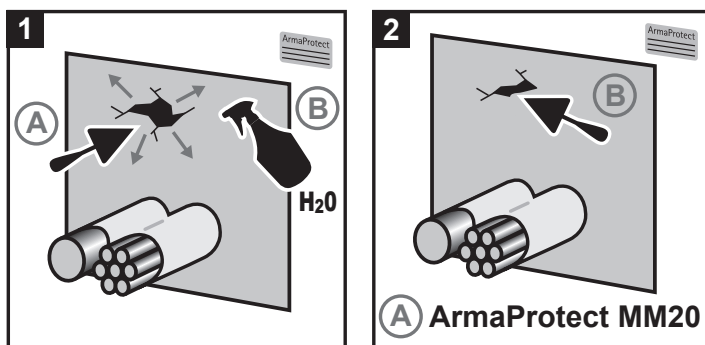

// Repenetration

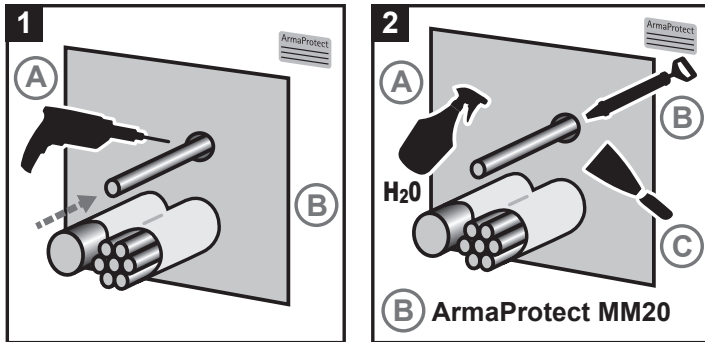

// Floor installation

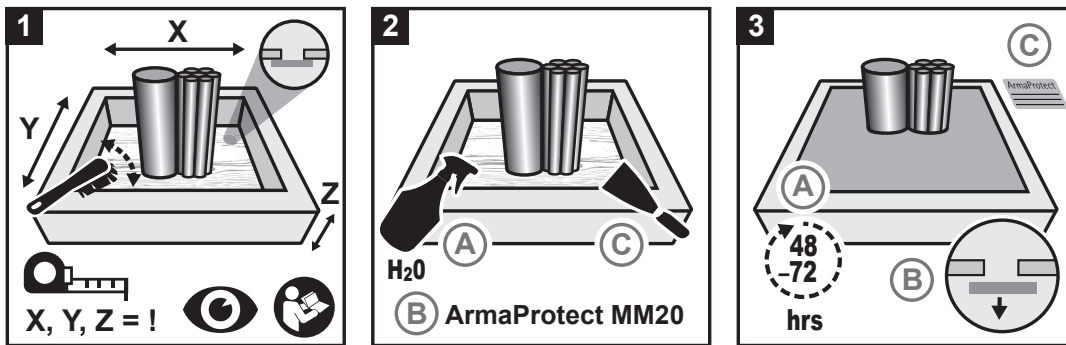

// Consumption guide

Approximate consumption [kg]

Maximum sealing size [m ²]	0% services	30% services	60% services
0.01	0.90	0.63	0.36
0.02	1.80	1.26	0.72
0.03	2.71	1.89	1.08
0.05	4.51	3.16	1.80
0.10	9.02	6.32	3.61
0.20	18.05	12.63	7.22
0.30	27.07	18.95	10.83
0.50	45.12	31.58	18.05
1.00	90.23	63.16	36.09

Take note of potential material loss during application at the job site.

UL APPROVED SYSTEMS

// Typical UL approved systems¹

Penetrants

- | | |
|-------------------|----------------|
| • Cables trays | ≤ 500 mm width |
| • Busbars | ≤ 300 mm width |
| • PVC or PE pipes | ≤ 110 mm dia |
| • Climaspits | ≤ 50 mm dia |

¹ See relevant UL system for further installation details.

// Selected exemplary UL approved systems

System No. C-AJ-6057 (busbar in wall and floor opening)

ANSI/UL 1479 (ASTM E814)

- F rating - 3 hours
- T rating - 1 hour

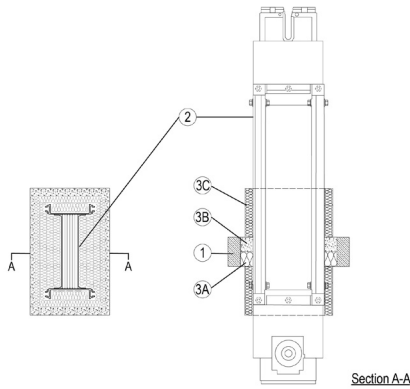

System No. F-A-4028 (cable tray in floor opening)

ANSI/UL 1479 (ASTM E814)

- F rating - 3 hours
- T rating - 1 hour

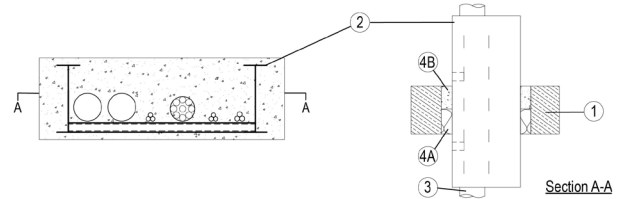

System No. W-J-4112 (cable tray in wall opening)

ANSI/UL 1479 (ASTM E814)

- F rating - 2 hours
- T rating - 1/2 hour

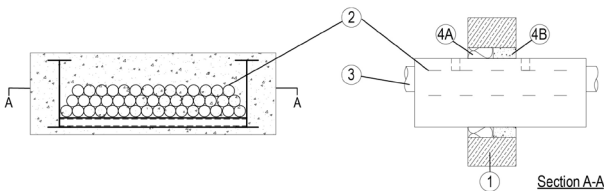

System No. W-J-8099 (climasplit in wall opening)

ANSI/UL 1479 (ASTM E814)

- F rating - 3 hours
- T rating - 1 1/2 hours

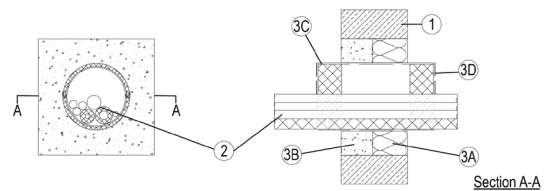

TECHNICAL DATA - ARMAPROTECT MM FIRESTOP MORTAR

Brief description	ArmaProtect MM20 is a fibre-free dry firestop mortar used to maintain the fire resistance performance of fire penetrations in wall and floors.
Material type	Fibre-free dry mortar.
Additional material information	4.0–5.0 l water + 25 kg dry mortar ≈ 15–18 l ready-to-use wet mortar ≈ 15–18 l volume after hardening.
Product colour range	Grey
Product range	Available as a 25 kg bag of mortar.
Applications	Firestop mortar for mixed fire seals in walls and floors, cables, cable bundles and cable trays and combustible pipes.
Installation	For professional use only. Refer to third party published listings, national approvals / assessments and Armacell's product literature for specific application details as well as before handling this product.
Declaration of Performance (DoP)	ArmaProtect MM20

Approvals and compliance

Specification compliance	<ul style="list-style-type: none"> UL acc. UL 1479 (ASTM E814)
--------------------------	---

Property	Value/Assessment	Standard/Test method
Temperature range		
Operating temperature	5 °C to 200 °C (41 °F to 392 °F)	
Application temperature	5 °C to 25 °C (41 °F to 77 °F)	
Storage and transportation temperature	5 °C to 25 °C (41 °F to 77 °F)	
Mechanical properties		
Dry bulk density	1.75 KG/DM3 ± 10 %	EN 998-2
Bulk density	2000 kg/m3 ± 10 %	EN 998-2
Pressure resistance	M 20	EN 998-2
Fire performance		
Reaction to fire	Class A1	EN 13501-1
Resistance to fire	See Annex	
Health and environment		
Emission of dangerous substances	No dangerous substances.	ETAG 026-02
Other technical features		
Cure time	Fully cured after approximately 28 days.	
Safety information	Please refer to the safety data sheet available on our website.	
Shelf life	Can be kept for at least 12 months unopened if stored properly.	
Storage	Store in a cool and dry place with an ambient temperature of 5 °C to 25 °C and protect from frost.	
Approved UL Systems	C-AJ-6057, F-A-2377, F-A-4028, F-A-4030, F-A-8066, W-J-2379, W-J-4110, W-J-4112, W-J-8099.	

Firestop mortar

Item	Description	Content
PRO-MM-25kg	ArmaProtect MM20 Firestop mortar	25 kg

Firestop wrap

Item	Description	Content
PRO-FW1-10m	ArmaProtect FW1 Firestop wrap	10 m
PRO-FW2-10m	ArmaProtect FW1 Firestop wrap	10 m

Firestop identification plate.

Item	Description	Content
PRO-ID-SET	ArmaProtect ID identification plate set	5 pieces

All data and technical information are based on results achieved under the specific conditions defined according to the testing standards referenced. Despite taking every precaution to ensure that said data and technical information are up to date, Armacell does not make any representation or warranty, express or implied, as to the accuracy, content or completeness of said data and technical information. Armacell also does not assume any liability towards any person resulting from the use of said data or technical information. Armacell reserves the right to revoke, modify or amend this document at any moment. It is the customer's responsibility to verify if the product is suitable for the intended application. The responsibility for professional and correct installation and compliance with relevant building regulations lies with the customer. This document does not constitute nor is part of a legal offer or contract. By ordering/receiving product you accept the Armacell General Terms and Conditions of Sale applicable in the region.

At Armacell, your trust means everything to us, so we want to let you know your rights and make it easier for you to understand what information we collect and why we collect it. If you would like to find out about our processing of data, please visit our Data Protection Policy.

© Armacell, 2023. All rights reserved. Trademarks followed by ® or ™ are trademarks of the Armacell Group.

00695 | ArmaProtect MM20 | ArmaProtect | PDS | 012023 | APAC | en-IN

ABOUT ARMACELL

As the inventors of flexible foam for equipment insulation and a leading provider of engineered foams, Armacell develops innovative and safe thermal, acoustic and mechanical solutions that create sustainable value for its customers. Armacell's products significantly contribute to global energy efficiency making a difference around the world every day. With more than 3,000 employees and 27 production plants in 19 countries, the company operates two main businesses, Advanced Insulation and Engineered Foams. Armacell focuses on insulation materials for technical equipment, high-performance foams for high-tech and lightweight applications and next generation aerogel blanket technology.



For more information, please visit:
www.armacell.com